

Gehäuse Oberteil

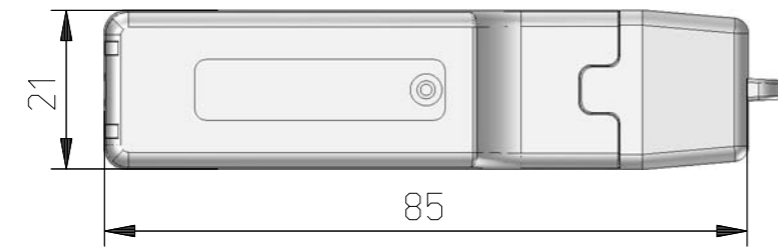

Gehäuse Unterteil

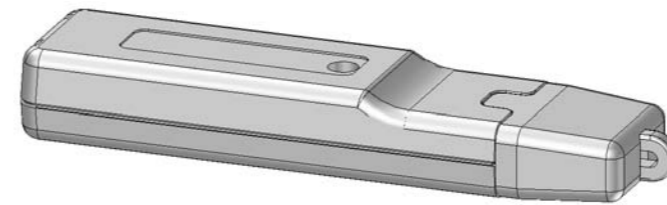
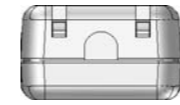
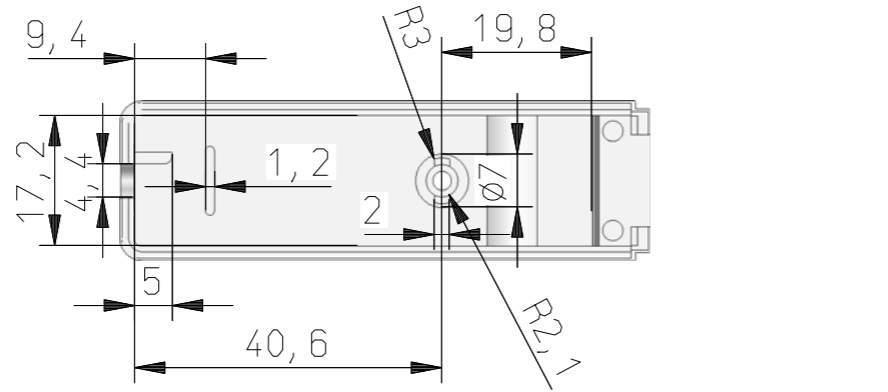
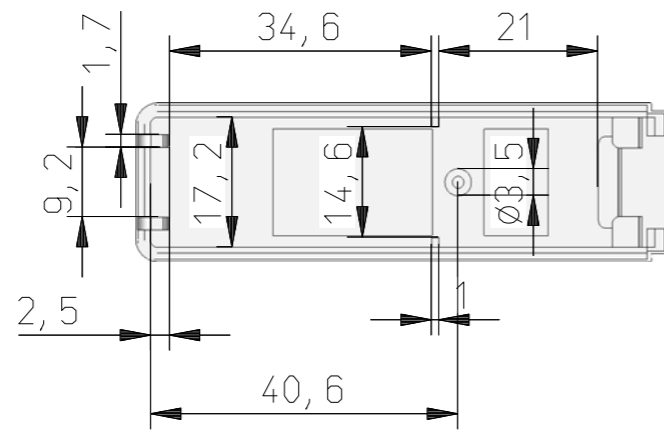

PCB Vorschlag

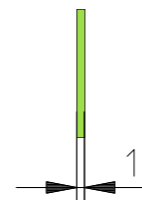
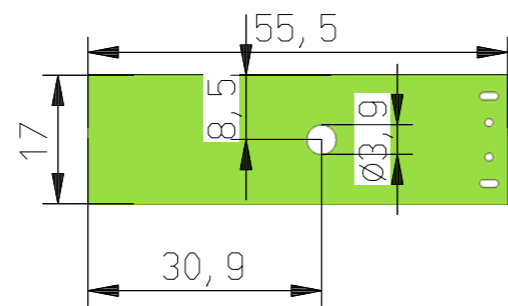

 www.WoehrGmbH.de		Maßstab: 1:1		Gewicht:		
		Schutzvermerk nach DIN 34 beachten / Freimasstoleranzen nach DIN 7168 mittel				
		Datum	Name		Serie GH02SG001 Verschraubung mit Kabelabgang	
		Bearb.	A.Schiele			
		Gepr.				
		Norm				
		ca				
					Material: ABS	
Zust.	Änderung	Datum	Name	Urspr.	Ers. f.:	Ers. d.: